

BIGBAT

12V. 26 Ah.

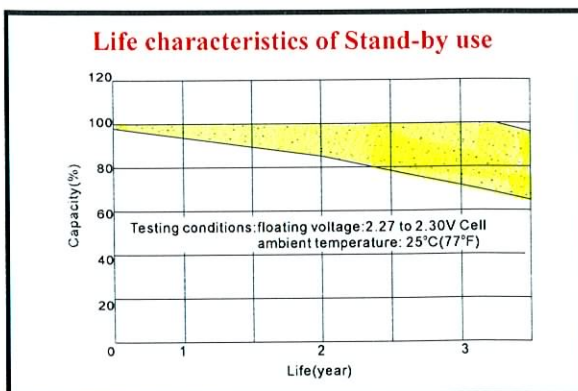
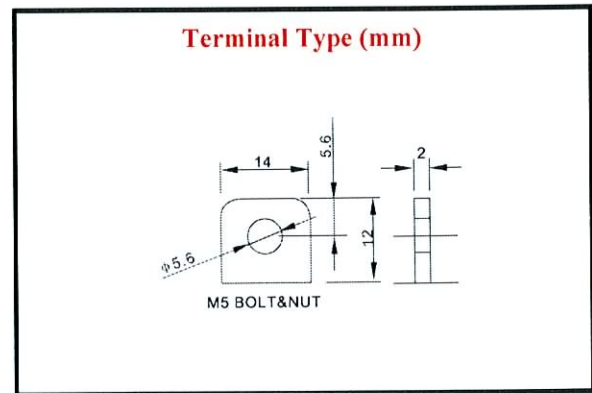
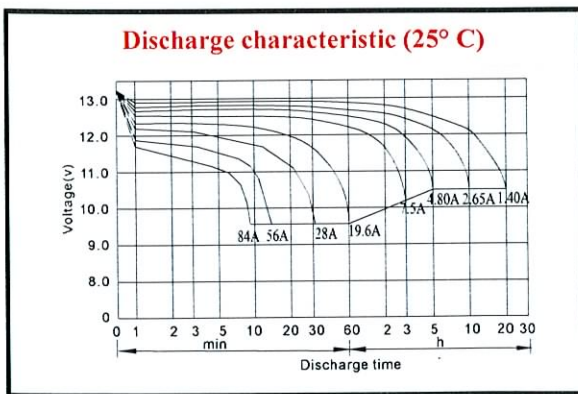
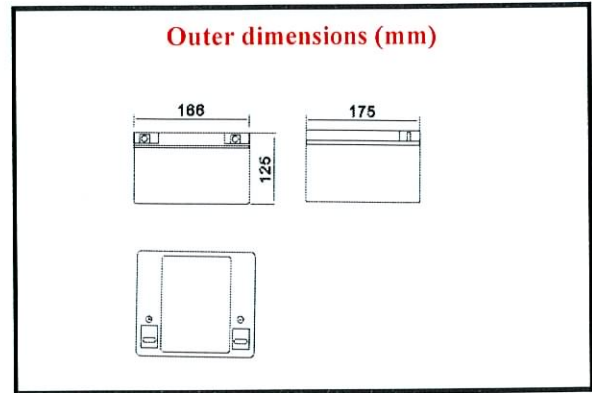
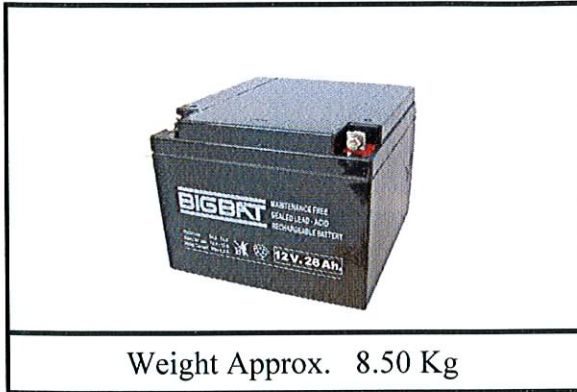

Characteristics

Capacity 25° C (77° F)	20 hour rate (1.30 A) 10 hour rate (2.39 A) 5 hour rate (4.42 A) 1 hour rate (15.60 A)	26.0 AH 23.9 AH 22.1 AH 15.6 AH
	1.5 hour discharge to 10.5V	10.4 A
Internal Resistance	Full charged battery at 25° C (77° F)	8 m Ω
Capacity effected by temperature (20 hour rate)	40° C (104° F) 25° C (77° F) 0° C (32° F) -15° C (5° F)	102 % 100 % 85 % 65 %
Self-discharge at 25° C (77° F)	Capacity after 3 month storage Capacity after 6 month storage Capacity after 12 month storage	91 % 82 % 64 %
Charge (constant voltage)	Cycle	Initial charging current less than 8.6 A Voltage 14.50 – 14.90V.
	Float	Voltage 13.60 – 13.80V.

