

BIGBAT

12V. 7 Ah.

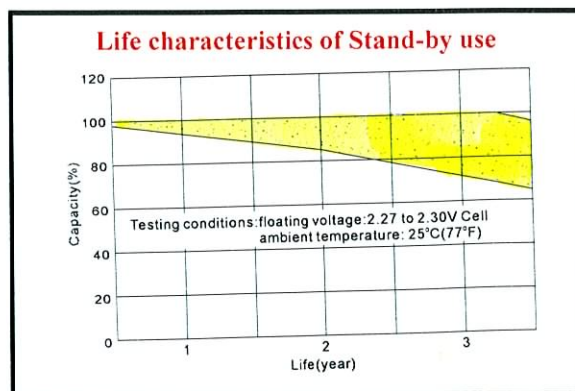
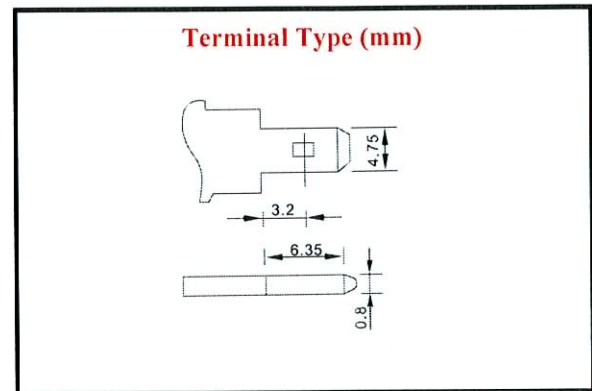
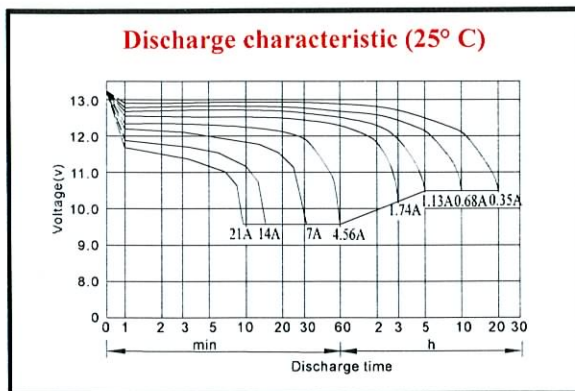
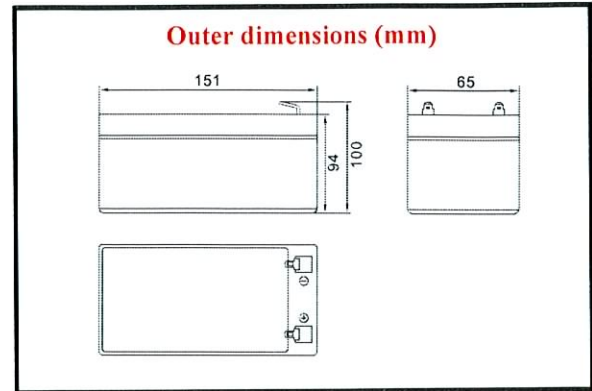

Characteristics

Capacity 25° C (77° F)	20 hour rate (0.35 A) 10 hour rate (0.68 A) 5 hour rate (1.13 A) 1 hour rate (4.56 A)	7.00 AH 6.80 AH 5.65 AH 4.56 AH
	1.5 hour discharge to 10.5V	2.8 A
Internal Resistance	Full charged battery at 25° C (77° F)	22 m Ω
Capacity effected by temperature (20 hour rate)	40° C (104° F) 25° C (77° F) 0° C (32° F) -15° C (5° F)	102 % 100 % 85 % 65 %
Self-discharge at 25° C (77° F)	Capacity after 3 month storage Capacity after 6 month storage Capacity after 12 month storage	91 % 82 % 64 %
Charge (constant voltage)	Cycle	Initial charging current less than 2.30 A Voltage 14.50 – 14.90V.
	Float	Voltage 13.60 – 13.80V.

