

BIGBAT

6V. 4.5 Ah.

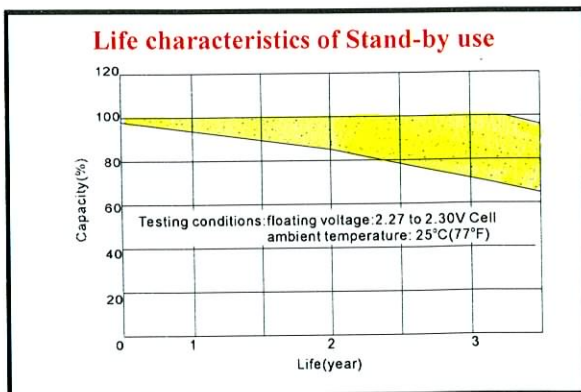
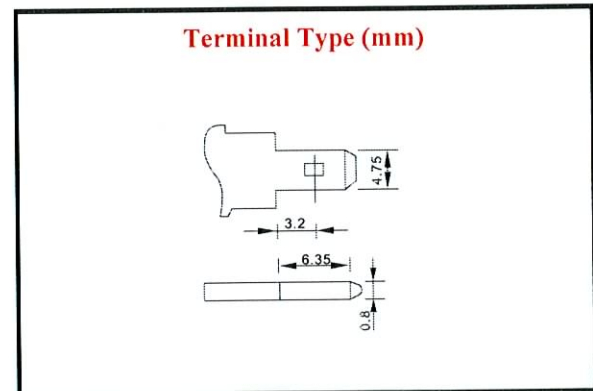
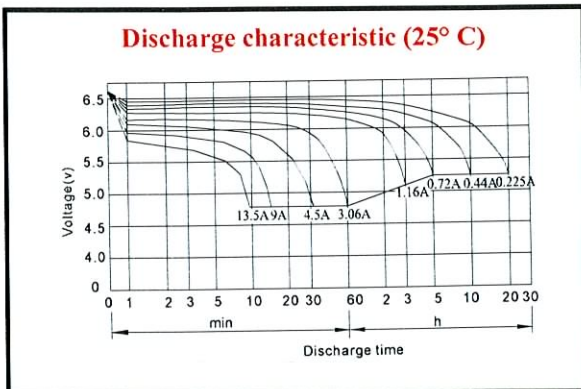
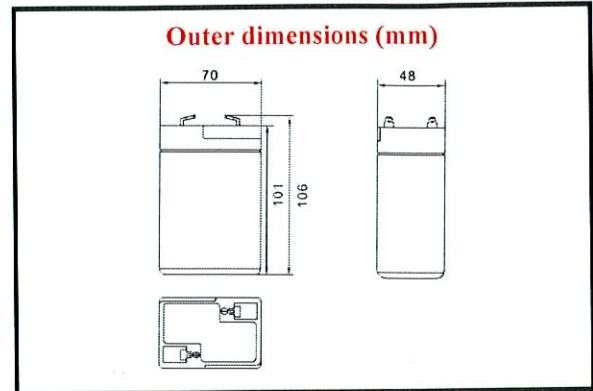
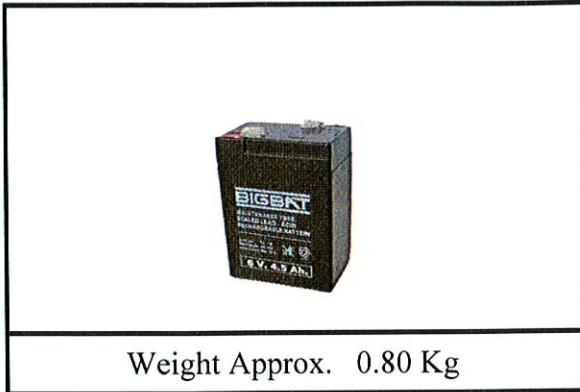

Characteristics

Capacity 25° C (77° F)	20 hour rate (0.225 A)	4.50 AH
	10 hour rate (0.44 A)	4.40 AH
	5 hour rate (0.72 A)	3.60 AH
	1 hour rate (3.06 A)	3.06 AH
	1.5 hour discharge to 5.25V	1.80 A
Internal Resistance	Full charged battery at 25° C (77° F)	16 m Ω
Capacity effected by temperature (20 hour rate)	40° C (104° F)	102 %
	25° C (77° F)	100 %
	0° C (32° F)	85 %
	-15° C (5° F)	65 %
Self-discharge at 25° C (77° F)	Capacity after 3 month storage	91 %
	Capacity after 6 month storage	82 %
	Capacity after 12 month storage	64 %
Charge (constant voltage)	Cycle	Initial charging currentless than 1.5 A Voltage 7.30 – 7.50V.
	Float	Voltage 6.90 – 7.00V.

