

BIGBAT

6V. 3.2 Ah.

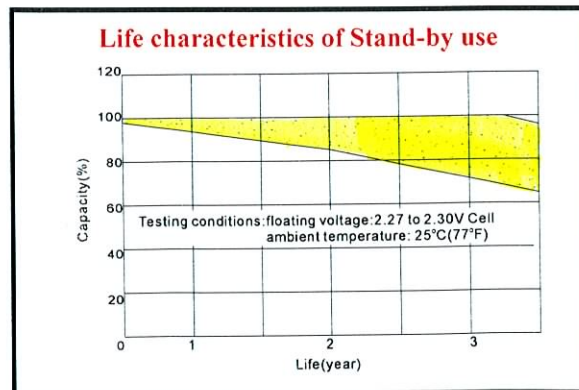
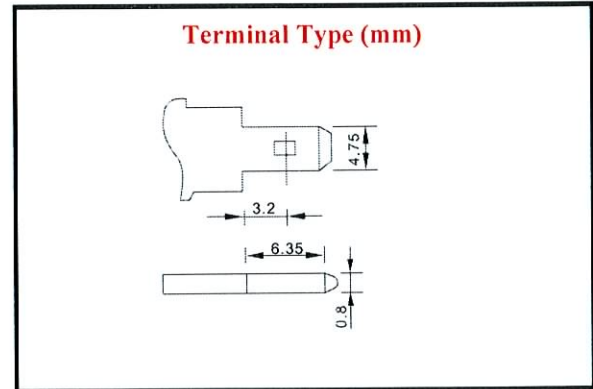
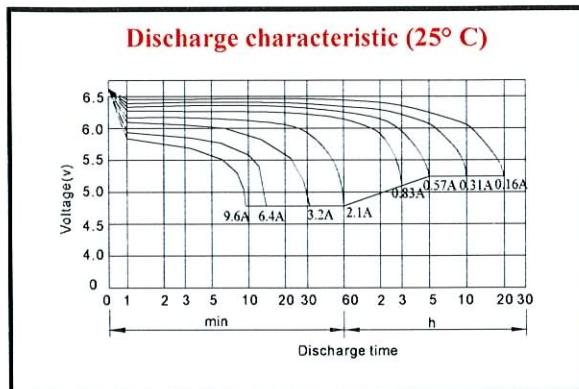
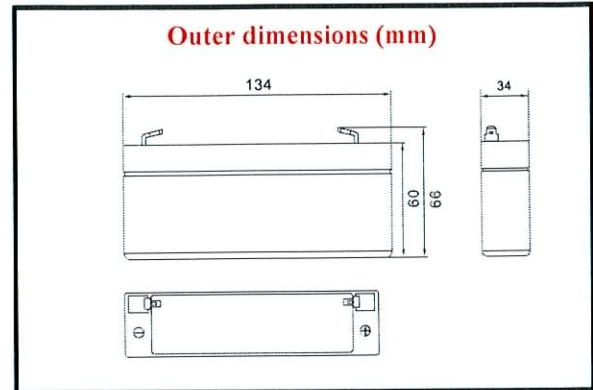
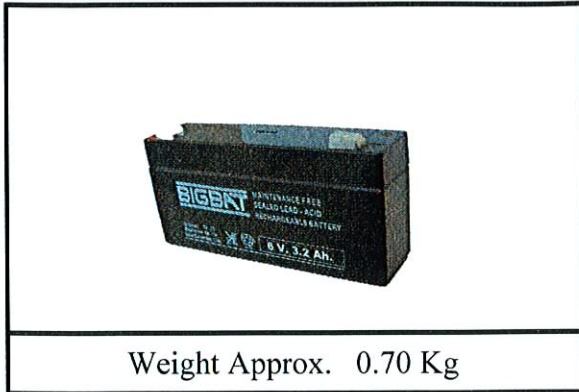

Characteristics

Capacity 25° C (77° F)	20 hour rate (0.16 A) 10 hour rate (0.31 A) 5 hour rate (0.57 A) 1 hour rate (2.10 A)	3.20 AH 3.10 AH 2.85 AH 2.10 AH
	1.5 hour discharge to 5.25V	1.28 A
Internal Resistance	Full charged battery at 25° C (77° F)	28 m Ω
Capacity effected by temperature (20 hour rate)	40° C (104° F)	102 %
	25° C (77° F)	100 %
	0° C (32° F)	85 %
	-15° C (5° F)	65 %
Self-discharge at 25° C (77° F)	Capacity after 3 month storage	91 %
	Capacity after 6 month storage	82 %
	Capacity after 12 month storage	64 %
Charge (constant voltage)	Cycle	Initial charging current less than 1.0 A Voltage 7.30 – 7.50V.
	Float	Voltage 6.90 – 7.00V.

